

1.0 Tools Required

1. Standard carpenters square
2. Standard carpenters level
3. Caulking gun
4. Measuring tape
5. Power drill
6. 1/4" Masonry drill bit
7. Standard Robertson screwdriver #2 (red handle)
8. Standard Robertson screwdriver #1 (green handle)
9. Standard flat screwdriver
10. Rubber mallet

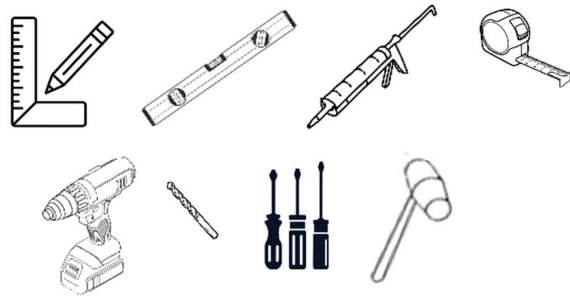

1.1 Materials Required

1. A number of shims (cedar shingles)
2. A cartridge of butyl type caulking
3. Low expansion foam insulation

1.2 Parts List: Please check and identify all the component parts and hardware of your door. Notify the place of purchase immediately if you are missing any of the required parts.

1.3 Frame Components:

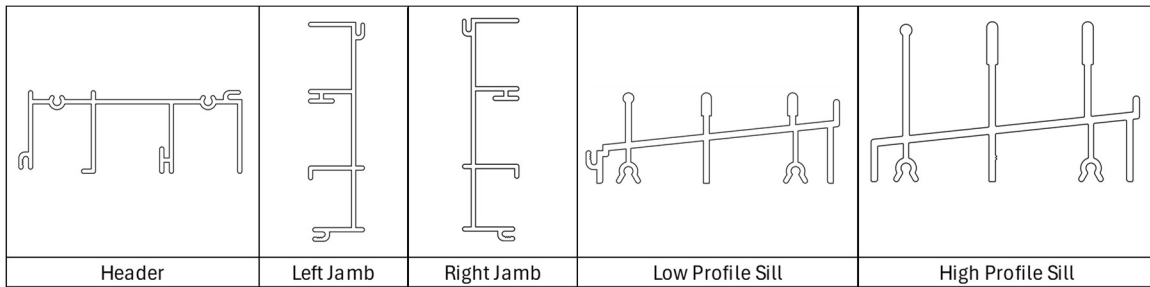

Figure 1

A. Two glass panels, one screen. (Note: if you have purchased a double-glazed door, two of the panels will contain insulating glass units. These are normally mounted on the outside.)

1.4 Parts Hardware	Qty.
1. Operating panel door lock hardware kit	1
2. Combination fixed panel security clip and bumper	2
3. #6 x 3/4" Panhead screws (frame assembly)	8
4. #10 x 1 1/2" Flathead Countersunk screws (sill installation)	2
5. 1/4" x 1" Plastic Anchor (sill installation)	2
6. #10 x 1 1/2" Panhead Taping screws (Frame installation)	9
7. Recessed bumpers	1
8. #8 x 3/4" self drilling screws (panel clip)	3
9. Screen Lock Hardware Kit	1



2.0 Preparation of Opening

2.1 The opening should be framed in wood on either a wooden or cement sill. 1/4" of space is reserved at the top and 1/2" is reserved at the sides to permit the use of wood shingles to square the aluminum frame.

Door Size	Width Opening Size	Actual Door Frame	Height Opening Size	Actual Door Frame
5'	60"	59 1/2"	80"	79 5/8"
6'	72"	71 1/2"	80"	79 5/8"
8'	96"	95 1/2"	80"	79 5/8"

Figure 2

3.0 Frame Assembly

3.1 Lay out the frame members and compare sections with illustrations in figure 1:

Sill Section (bottom)

Header (top)

Left Jamb (Side)

Right Jamb (Side)

3.2 Assemble the frame using the #6 x 3/4" panheads screws (#3). Refer to figure 3.

3.3 Apply silicone at frame joints Tremsil 600 or better.

3.4 Ensure jamb notching is aligned correctly with header and sill. Ensure sill is sloping to the outside.

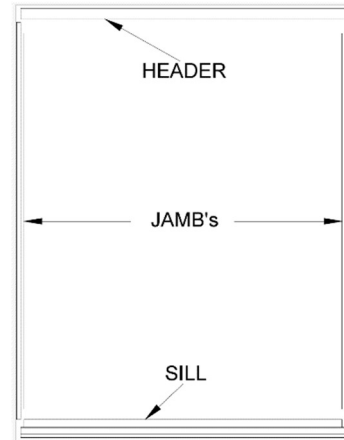

Figure 3

4.0 Frame Installation

4.1 Important: Careful caulking will prevent leakage. Run a 1/2" bead of caulking down each side of the underside of the inside part of the sill. Caulk the full length of the joint of the sill and header at each of the jambs. Place a generous spot of caulking over each screw holes in the sill. Slip the assembled frame into the prepared opening making sure that the sill slopes down to the outside. Using the wooden shingles behind the frame at each of the screw holes and guided by a carpenter's level and square, square the jambs and header to the level sill. Use the #10 x 1/4" countersunk screw (#4) to fasten down the sill. If the sill is concrete, make 1/4" holes in the concrete at every installation screw hole using a 1/4" concrete drill bit. Insert the 10 x 12 x 1 (#5) anchor plugs and then use the 10 x 1 1/4" (#4) countersunk screws. Apply generous silicone sealant into sill installation holes, prior to fastening the #10 x 1 1/4" countersink screws. Make certain that the frame remains square until it is firmly fastened. Fill insulation firmly into any space between the aluminum frame and the wood opening frame to prevent drafts. See figure 4.

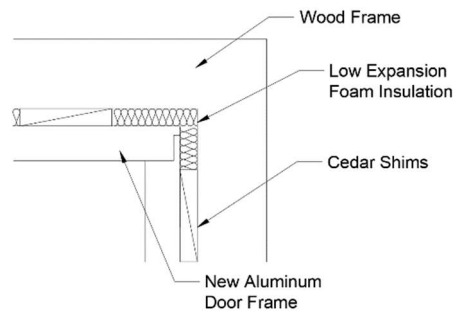

Figure 4

5.0 Panel Installation and Operation

5.1 First check all panels for squareness. Panels can become out of square while being transported. You can adjust using a mallet and a wooden block. See figure 5.

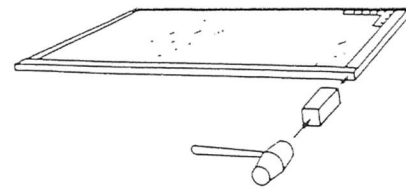

Figure 5

5.2 Panel operation shown is as viewed from the outside. Install the first panel as shown in figures 5 or 6 by lifting the top up into the header section and then resting the bottom on the corresponding track on the sill. Adjust the panel wheels (figure 6) so that the panel is square to the jambs (side) and operates smoothly. Move this panel to the middle.

5.3 Now load the second panel as shown again adjust the panel wheels.

5.4 Adjust the dust caps located at the top of the fixed panels to prevent lifting the panels to remove.

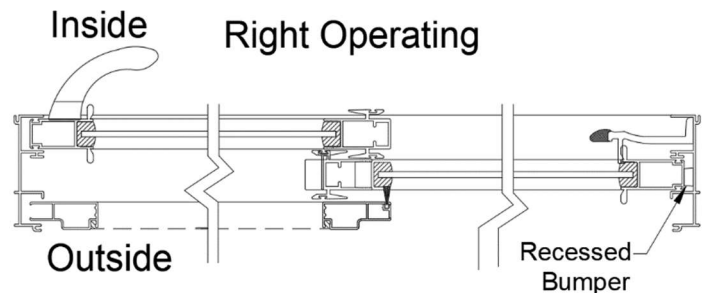

Figure 6

6.0 Mounting the Hardware

6.1 Install the vinyl panel bumpers (#7) using the #8 x 3/4" self tapping screws (#8) into the centre of the jambs, behind the fixed panel. (Note: this bumper is installed where the fixed panel meets the jamb. They are used to provide the proper spacing for the panel clip to hold securely).

6.3 Install the combination fixed panel clip and bumper. Make sure that the clip is tight against the glass before starting the #8 x 3/4" self tapping screws (#10).

6.4 Install the operating panel door lock (#1) in the opening provided. With the lock in the locked position place the lock keeper over the cam and ease the panel close to the jamb. Mark the approximate position of the keeper. Move the panel and install the keeper using the screws provided.

6.4 Install the outside screen handle using the #8 x 1/2" self tapping screws (#7). Install the screen keeper in the same way you installed the operating panel keepers, using the #6 x 1/2" self tapping screws (#9) and you are finished!

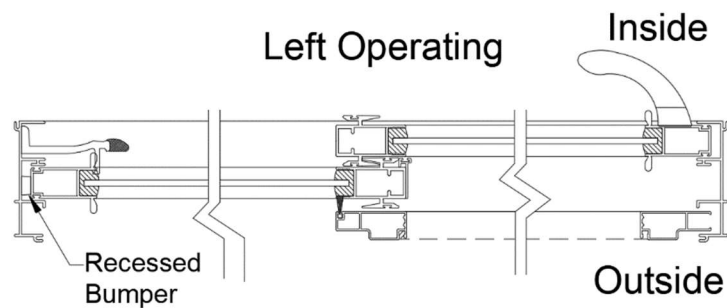

Figure 7

7.0 Maintenance

7.1 Keep the sill section clean to extend the life of the ball bearing rollers. Use liquid glass cleaner, never abrasive based cleaners, to clean all surfaces (Note: Rinse the sill thoroughly as soap residue will harm the sill finish). To adjust the panels, move the operating panels until they are out of the jamb approximately 1/8". Adjust the screw on the opposite side until the side rail of the panel is parallel to the jamb section. To adjust the screen, use the screws located at each corner of the screen. Adjust the bottom rollers first to achieve the desired height, then adjust the top rollers to provide the required tension or balance.

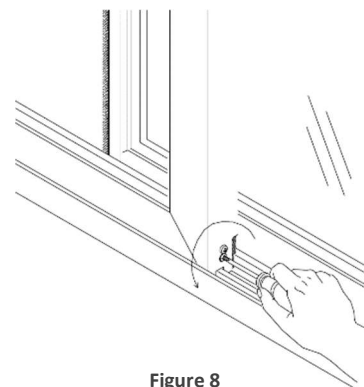

Figure 8

8.0 INSTALLING THE SCREEN PANEL

8.1 Before installing the screen, back-off all four wheels by turning the adjustment screws counter-clockwise as shown.

8.2 Insert the screen in the outside track of the frame header, swing the bottom of the screen towards the sill and snap the rollers over the sill screen track as shown. Slide the screen in the closing direction to within 1/4" of the jamb. Visually, the gap between the screen and the jambs should be uniform from top to bottom.

8.3 Using a screwdriver (#2-Robertson or #2-Phillips) adjust the rollers on the bottom of the screen up (clockwise) or down (counter-clockwise) to align the screen as shown above. Adjust the top rollers just enough to snug the screen in the top track and allow easy rolling.

8.4 Install interior locking handle and exterior handle to the screen.

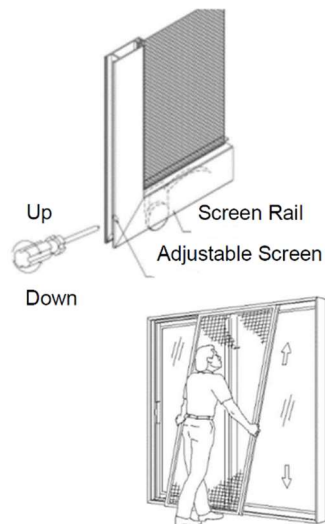

Figure 9

Visit Our Web Site @ www.clearview.on.ca

CLEARVIEW
INDUSTRIES LTD

45 Fenmar Drive
Toronto, Ontario Canada M9L1M1
Toll: 1-888-253-2739
Tel: 416-745-6666
Fax: 416-745-3711
E: sales@clearview.on.ca