

**Assembly and Installation Guide of 7000-3T Series Sliding Door**

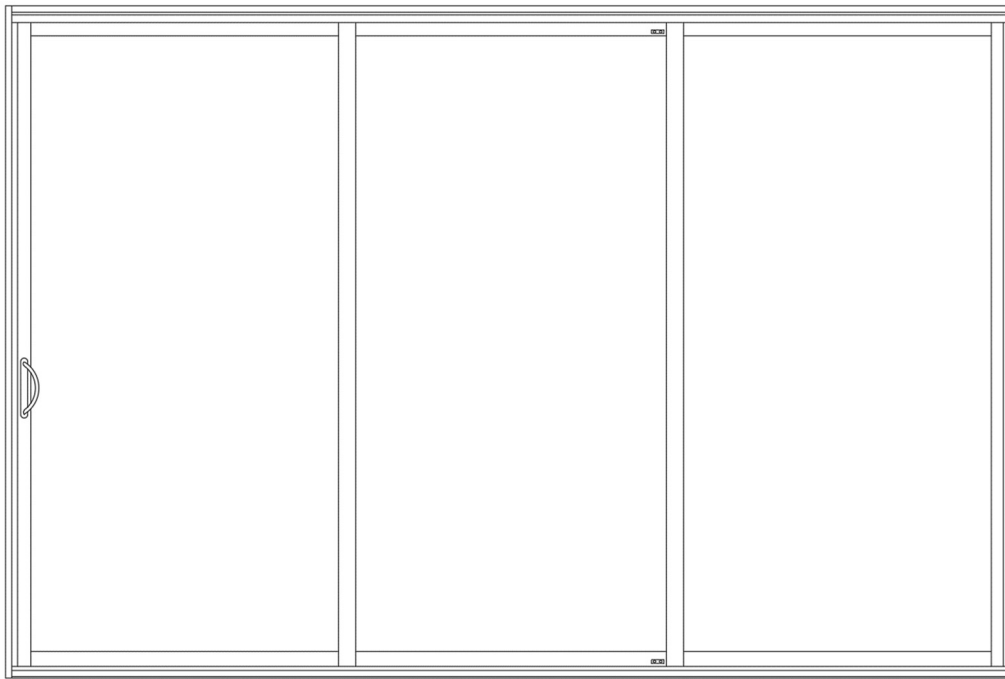

**Inside View Elevation**

**NOTICE**

READING THESE INSTRUCTIONS FIRST AND FOLLOWING THE PROCEDURES IN PROPER SEQUENCE  
WILL REDUCE COSTLY MISTAKES AND WASTED TIME.







|   |  |       |  |  |        |
|---|--|-------|--|--|--------|
|     | <p><b>Main Frame Header</b></p>  | 1 Pc  |    | <p><b>#8x1-1/2" Pan Head Screws</b></p> <p>For main frame assembly.</p>  | 22 pcs |
|   | <p>Aluminum frame extrusion. Used for the header. Includes 2 neoprene foam blocks in centre. (factory installed).</p>        |       |  | <p><b>#8x3" Pan Head Screws</b></p> <p>For rough opening installation</p>  | 20 pcs |
|    | <p><b>Main Frame Jamb (Left and Right)</b></p>   | 1 set |    | <p><b>#8x3/4" Pan Head Screws</b></p>  | 7 pcs  |
|   | <p>Aluminum frame extrusion. Used for the jambs (left and right sides). Includes Butyl foam gaskets (factory installed).</p> |       |  | <p>6-Screws used to attach the fixed panel clip's to the main frame making it stationary. 1-Screws for the anti-lift.</p>  |        |
|     | <p><b>Main Frame Sill B2 – STANDARD</b></p>  | 1 pc  |   | <p><b>Fixed Panel Clip</b></p>   | 2 pcs  |
|   | <p>Aluminum frame extrusion. Used for the B2 Sill. Includes drain hole baffle(s).</p>  |       |  | <p>The fixed panel clip is installed on the labels at the top and bottom of the frame and fixed panel.</p>   |        |
|  | <p><b>Mortise Lock Handle &amp; Keeper - STANDARD</b></p>  | 1 set |  | <p><b>Fixed Panel Clip Cover</b></p>   | 2 pcs  |
|   | <p>Interior &amp; exterior handle, Keeper allows operating frame to lock with main frame. Hardware bag included.</p>         |       |  | <p>The fixed panel clip covers snap onto of the fixed panel clip(s).</p>   |        |
|   | <p><b>Panel pickup</b></p>   | 2 Pcs |  | <p><b>Anti-Lift</b></p>  | 1 pc   |
|   | <p>Pre-installed on center operating panel on interior top and bottom.</p>   |       |  | <p>The anti-lift is installed in the header portion of the door frame above the operating panel where the panels interlock.</p>  |        |
|  | <p><b>Dust Pad</b></p>   | 2 Pcs |  | <p><b>Operating Panel Stop</b></p>   | 1 Pc   |
|   | <p>The Dust pad is pre-installed on the fixed panel(s) in the "backed-off" position (Factory Installed).</p>                 |       |  | <p>The operating panel stop is installed in the header portion of the door frame in front of the operating panel at the left or right jamb depending on the operation of the door.</p> |        |

Table 1

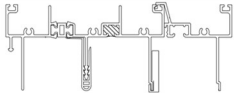
### 3T-PANEL DOOR – INSTALLATION INSTRUCTIONS

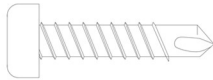
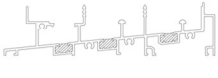
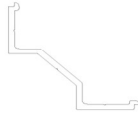
**GENERAL:** Door elevations shown in these instructions are as viewed from the outside.

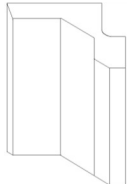
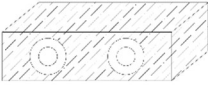
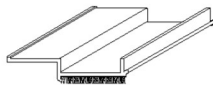

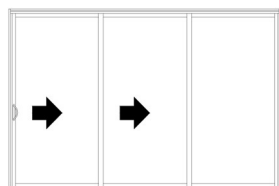
**"XXO" DOOR**

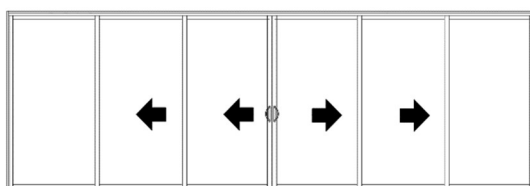

**"OXXXXO" DOOR**

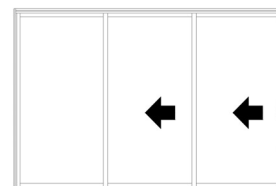

**"OXX" DOOR**

'X' denotes the active or operating panel(s).

'O' denotes the inactive or fixed panel(s).

**A) ROUGH OPENING PREPARATION:**

The rough opening should be made 1/2" wider and 3/8" higher (+/- 1/8" each way) than the actual door frame size (Refer to the chart for frame sizes). The sill or base of the opening must be solid, level and of sufficient width and depth to support the entire door sill in a continuous and uniform manner. It is important that the opening be plumb and square as the door will not perform to its potential if installed into an improperly prepared opening.

**7000 -3T Series Technical Specifications (6-1/2" Frame depth)**

| CONFIGURATION | SIZE  | Frame Size (in) |        |             | Rough Opening (in) |        |             |
|---------------|-------|-----------------|--------|-------------|--------------------|--------|-------------|
|               |       | Width           | Height | Tall height | Width              | Height | Height Tall |
| XXO or OXX    | 7668  | 87              | 79-5/8 |             | 87-1/2             | 80     |             |
| XXO or OXX    | 9068  | 105             | 79-5/8 |             | 105-1/2            | 80     |             |
| XXO or OXX    | 12068 | 141             | 79-5/8 |             | 141-1/2            | 80     |             |
| XXO or OXX    | 7678  | 86-1/4          |        | 92-5/8      | 86-3/4             |        | 93          |
| XXO or OXX    | 9078  | 104-1/4         |        | 92-5/8      | 104-3/4            |        | 93          |
| XXO or OXX    | 12078 | 140-1/4         |        | 92-5/8      | 140-3/4            |        | 93          |
| OXXXXO        | 15068 | 171-7/8         | 79-5/8 |             | 172-3/8            | 80     |             |
| OXXXXO        | 18068 | 207-7/8         | 79-5/8 |             | 208-3/8            | 80     |             |
| OXXXXO        | 24068 | 279-7/8         | 79-5/8 |             | 280-3/8            | 80     |             |
| OXXXXO        | 15078 | 170-3/8         |        | 92-5/8      | 170-7/8            |        | 93          |
| OXXXXO        | 18078 | 206-3/8         |        | 92-5/8      | 206-7/8            |        | 93          |
| OXXXXO        | 24078 | 278-3/8         |        | 92-5/8      | 278-7/8            |        | 93          |

Table 2

**1.0 FRAME ASSEMBLY:**

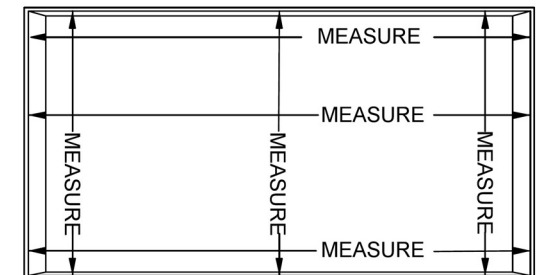

**Figure 1**

**1.1** The frame consists of 4 main thermally broken aluminum members:

1. Header Track
2. Sill Track
3. Left-hand Jamb
4. Right-hand Jamb

**1.2** All main frame members are machined so that they may be assembled in only one way. Lay out the framing members as shown in the diagram.

**1.3** Prior to assembling the frame, remove the paper backer from factory installed Butyl tape.

**1.4** Using the #8 x 1-1/2" screws provided; fasten the header and sill to the jambs as shown, make sure the screws are drawn tight.

**1.5** If the butyl pad is compromised or missing, apply a 1/8" bead of silicone from the bottom of the track to the top of the sill at the jamb joint and across the jamb lip. Apply to the left and right jamb joints.

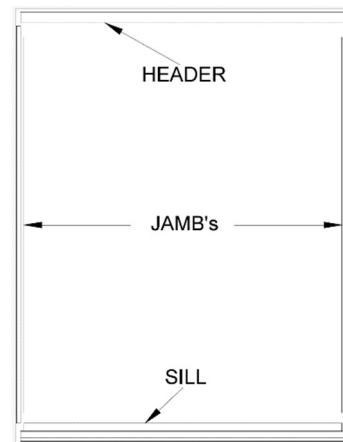

**Figure 2 - Outside Slope of Sill**

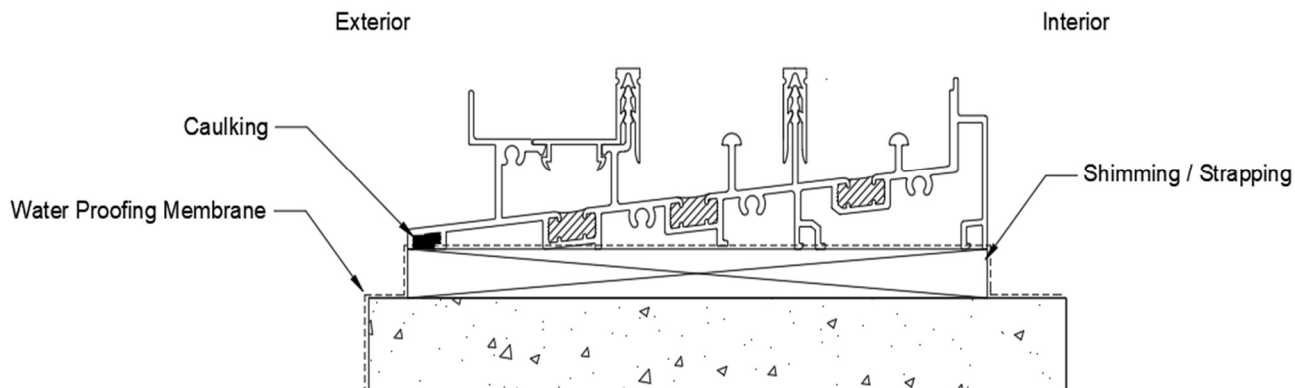

**Figure 3**

**2.0 FRAME INSTALLATION:**

**2.1** The main frame is always installed with the sill sloping to the outside.

**2.2** Apply a heavy continuous bead of good quality caulking/Butyl sealant or Self Adhesive Water Proofing Membrane (recommended) under the outside lip of the sill and insert the main frame into the opening as shown.

**2.3** Center the door frame within the rough opening leaving equal clearance at both jambs.

**2.4** The sill must be installed level and uniformly supported from left side to right side and from inside to outside. Use a level and use solid shims (every 16") if necessary to compensate for unevenness in the opening. Use brackets or angles that do not puncture the top of the sill if possible but if the use of screws cannot be avoided, ensure they are back sealed and covered with sealant. They must be waterproof. Apply sealant to all fasteners.

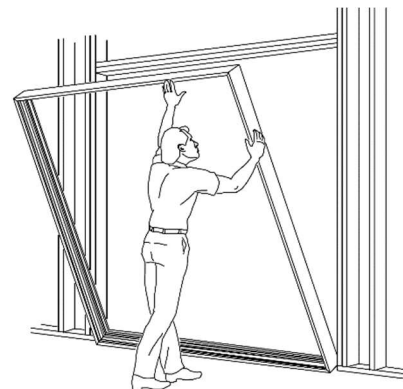

**Figure 4**

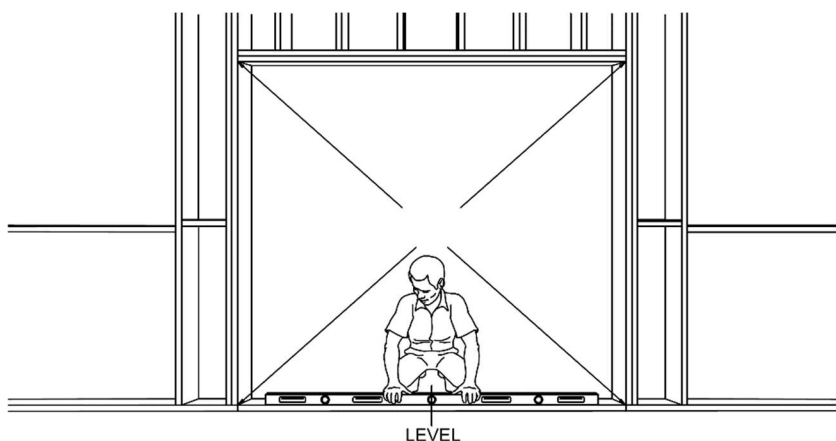

**Figure 5**

**2.4a** At a minimum, the header must be anchored above each meeting rail and location within 6" of each corner. The jambs must be anchored 6" from each corner and within 6" from the top and bottom of the lock keeper for the operating side, but more for oversized doors. Clearview strongly recommends that fasteners are installed in both the inner and outer tracks on the header and jambs.

**2.4b** For security it is recommended to install solid blocking between the jamb and the surrounding structure at the lock keeper location and to put installation screws through and directly above and below the keeper. All screws must engage the surrounding structure a minimum of 1".

**2.4c** It is the responsibility of the installer to drill the installation holes. Anchor the fixed side jambs within 6" of the center of the jamb.

**2.4d** Set shims behind the frame installation holes to make the mainframe plumb and square then temporarily fasten the frame to the surrounding structure. Using a level and measuring diagonally, check that the frame is straight, plumb and square, adjust the shims if necessary, and securely fasten all screws.

**2.4e** Once all shimmed, measure each diagonal direction and ensure they are within 1/4" tolerance, if difference is greater than 1/4", please adjust frame to ensure within 1/4".

**NOTE:** For installations in high-wind areas, attaching to window systems, or when using oversized doors, the quantity, size, type and engagement of the fasteners and the supporting shims should be as follows; Additional structural engineering consultation may be required.

**2.4f** Minimum #8 x 3" screw fastener or better at 6" from end and every 30" spaced out at even intervals for the jamb and header. Fasten 2 screws at each point, one in the exterior channel and the other in the interior channel. All screws must be supported with wood or pvc shimming material to allow for proper leveling.

**3.0 INSTALLING THE FIXED PANEL**

**3.1** From the outside of the building, lift the fixed panel into the furthest away/exterior track of the frame header and carefully lower onto the sill as shown. The wool pile at the meeting rail should now be facing the inside of the building.

**3.2** The fixed panel should be completely level with the sill, no gaps should be apparent between the sill and the bottom of the fixed panel. The black closed cell foam above the fixed panel should be tight to all edges and past the interlock by at least 1/4".

**3.3** Push the fixed panel securely and completely into the jamb.

**3.4** You may need to use silicone spray along the sill and up the jamb to fully engage the fixed panel. If additional assistance is required use a spreader bar to push the fixed panel firmly against the jamb.

**3.5** First fasten the fixed panel clip to the top and bottom of the fixed panel with #8x3/4" screws (as shown #1) as indicated by the label on the fixed pull rail. Now fasten the fixed panel clip to the top and bottom of the jamb with #8x3/4" screws (as shown #2) as indicated by the label on the jamb.

**3.6** Now place fixed panel clip covers over the fixed panel clips.

**3.7** With the fixed panel completely secured, apply a 1/8" bead of silicone starting from the exterior edge of the bottom fixed panel towards the interior all the way (as shown).

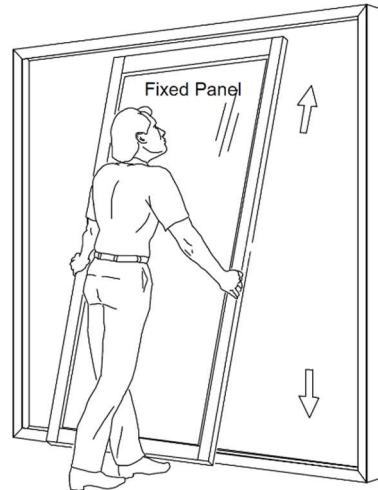

**Figure 6**

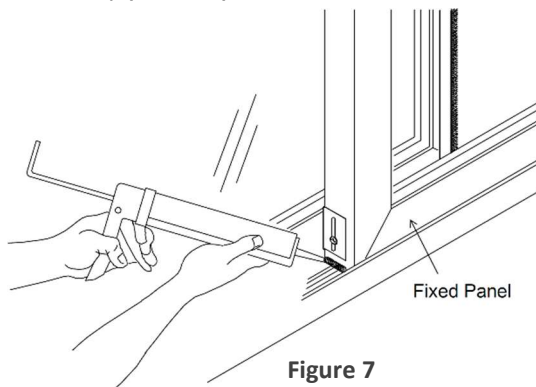

**Figure 7**

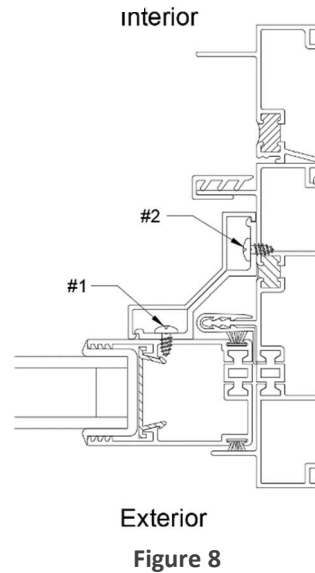

**Figure 8**

**4.0 DUST PAD ADJUSTMENT**

**4.1** The fixed panel is shipped with the dust pad's factory installed in the "backed-off" position. After the door has been completely aligned and adjusted, apply a small bead of silicone at the interlock / sill joint along the entire interlock and underneath the dust pad. Loosen the dust pad adjustment screws and raise or lower the dust pads so that one dust pad fits tightly against the head and one dust pad fits tightly against the sill of the doorframe and re-tighten the screws.

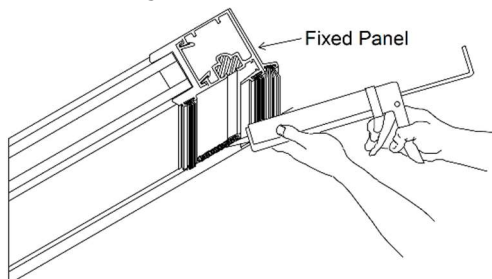

**Figure 9**

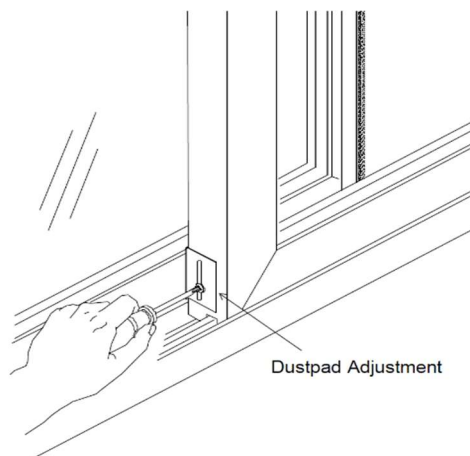

**Figure 10**

**5.0 INSTALLING THE OPERATING PANEL(S)**

**5.1** Once fixed panel installation is complete, locate center/intermediary operator, it can be identified by the panel pick-up device located at top and bottom inside of door panel. This device also indicates its orientation (panel pick-up facing device inside).

**5.2** Lift the center operating panel from the inside into the center track of the frame header and carefully lower onto the roller track of sill as shown. Be sure the panel is installed centered with the fixed panel interlock.

**5.3** Repeat the process with third panel (punched for lockset) onto third, innermost track.

**5.4** Using a handheld screwdriver (#2-Robertson or #2-Phillips), adjust the rollers up or down to align the top of the weather stripping on the outside of the bottom rail to be riding approximately 1/16" to 1/8" below the sill frost bar as shown.

**5.5** Turn the screw clockwise to raise the panel or counterclockwise to lower the panel as shown.

**NOTE:** Clearview recommends lifting the panel slightly when adjusting the wheels for ease of turning and to ensure against stripping the adjustment mechanism.

**5.6** Slide the panel in the closing direction to within 1/4" of the jamb. Visually, the gap between the panel and the jamb should be uniform from top to bottom. If not, adjust the panel downward at one corner until the panel aligns to the jamb. If the jamb is bowed, remove installation screws, adjust the shims, and re-fasten.

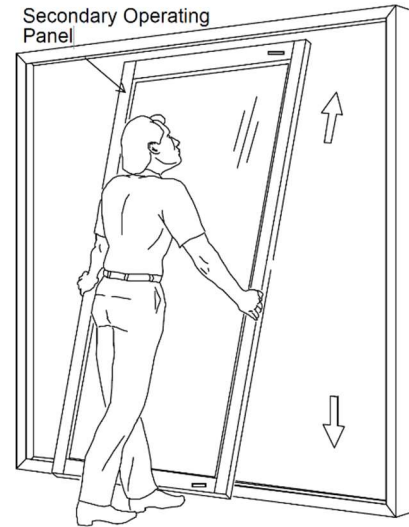

**Figure 11**

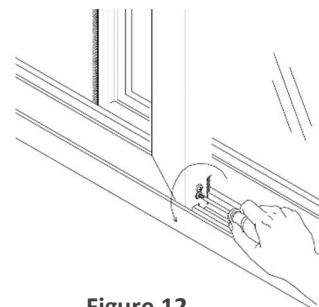

**Figure 12**

**6.0 MORTISE LOCK HANDLE AND KEEPER INSTALLATION**

**6.1** All hardware for locking the door is packaged separately. Follow the instructions enclosed in the hardware package for the following hardware option provided. Only after the panels have been adjusted as previously noted, attach the operating mechanism, handles, and lock keeper as outlined in the door hardware instruction sheet.

**6.2** Mortise Lock: Optional for all doors (except OXXO doors). Attach the operating mechanism and handles to the lock rail as shown. Ensure that the striker hook is facing upwards.

**NOTE:** Install the screws through the centre of the slots in the keeper to allow for future vertical adjustments if necessary.

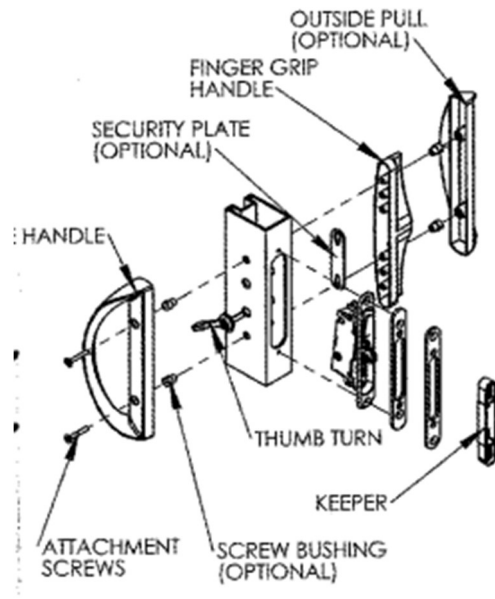

**Figure 13**

**7.0 CAULKING**

**7.1** Use good quality building sealant that is compatible with aluminum surfaces of the sliding door and the surrounding structure. (Check the application with your sealant supplier.) It is important that all aluminum surfaces to be caulked are free of dust, dirt and grease and are well cleaned. Depending on the sealant being used, a primer may also be necessary.

**NOTE: DO NOT caulk over the drain flaps when caulking across the sill.**

**8.0 INSTALLING ANTI-LIFT**

**8.1** The anti-lift is installed in the header portion of the door frame above the operating panels. This is a security precaution to prevent intruders from lifting the panel out while in the locked position.

**8.2** Slide the door to the full closed position; place the anti-lift into the header section where the panels interlock as shown.

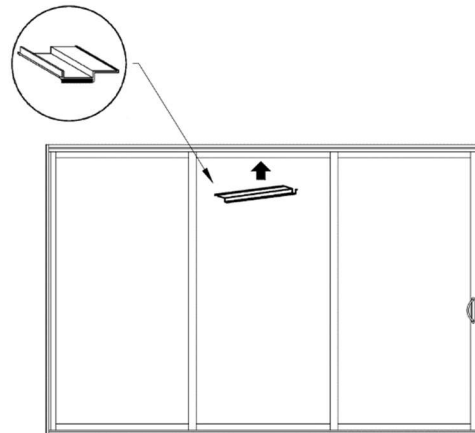

**Figure 14**

**9.0 INSTALLING OPERABLE PANEL STOP**

**9.1** The panel stop bumper is installed in the header portion of the door frame in-front of the fixed panel at the far left or right (depending on operation) beside the jamb as shown.

**10.0 7000-3T Panel Door XXO/OXX Configuration**

**10.1 General Parts Location**

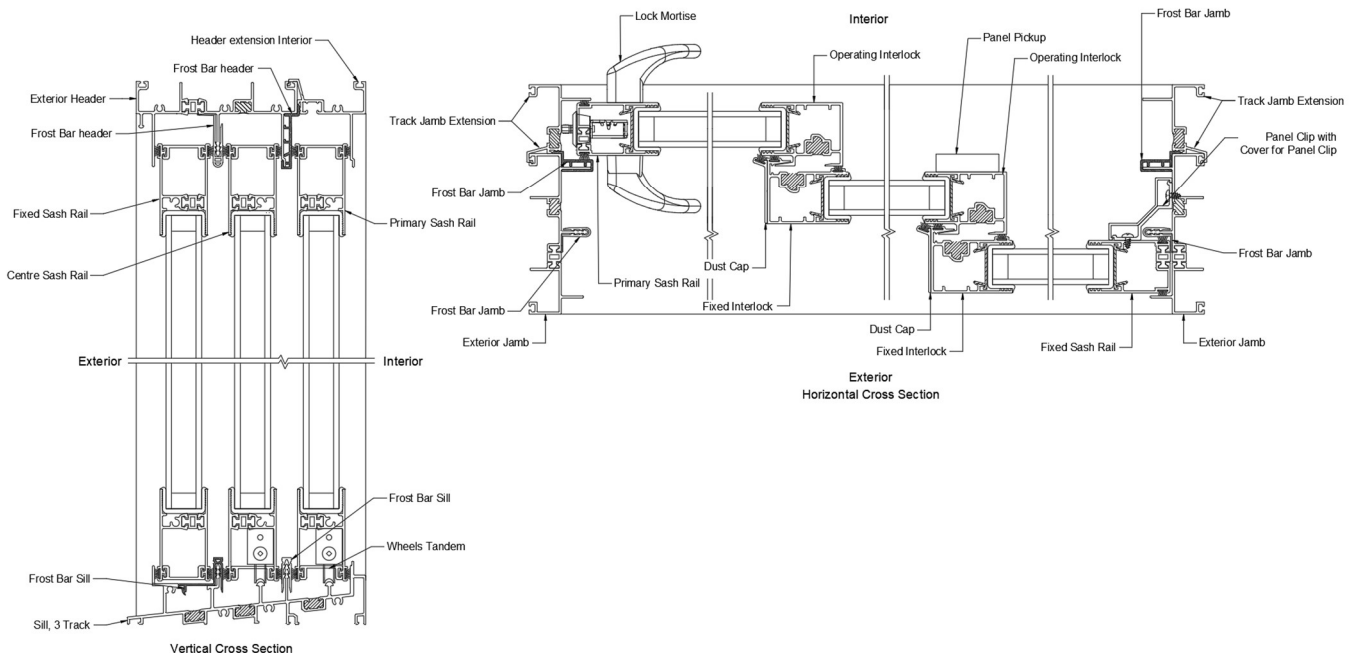

**Figure 15**

Visit Our Web Site @ [www.clearview.on.ca](http://www.clearview.on.ca)

**CLEARVIEW**  
INDUSTRIES LTD

45 Fenmar Drive  
Toronto, Ontario Canada M9L1M1  
Toll: 1-888-253-2739  
Tel: 416-745-6666  
Fax: 416-745-3711  
E: [sales@clearview.on.ca](mailto:sales@clearview.on.ca)