

How to Reverse a Door Guide – Vinyl 2 Panel Sliding Door

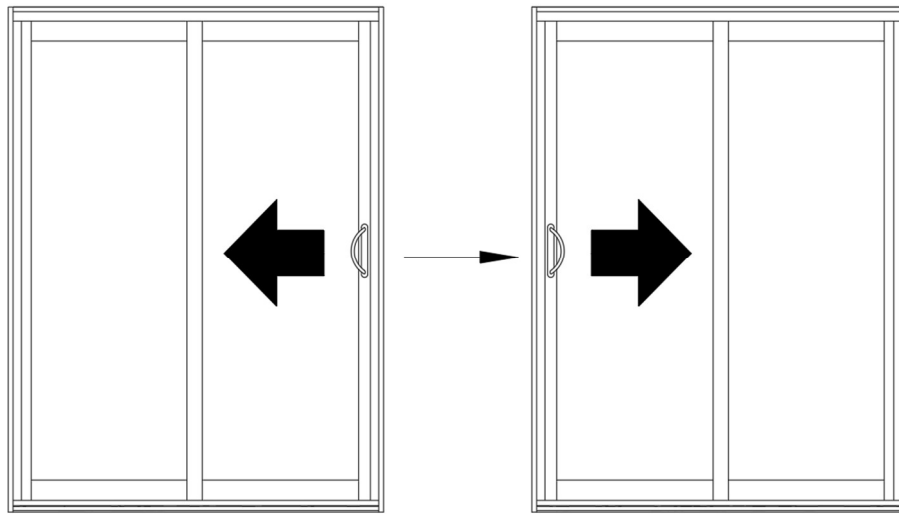

Inside View Elevation

1.0 Reverse the Fixed Panel

1.1 To remove the fixed panel, remove the slide covers located at the top and bottom of interlock and bumpers located at the top and bottom of the frame and fixed panel. Push the fixed panel securely from the jamb. Lift the panel and pull it out of the frame; the bottom part of the panel should come out first (Figure 1).

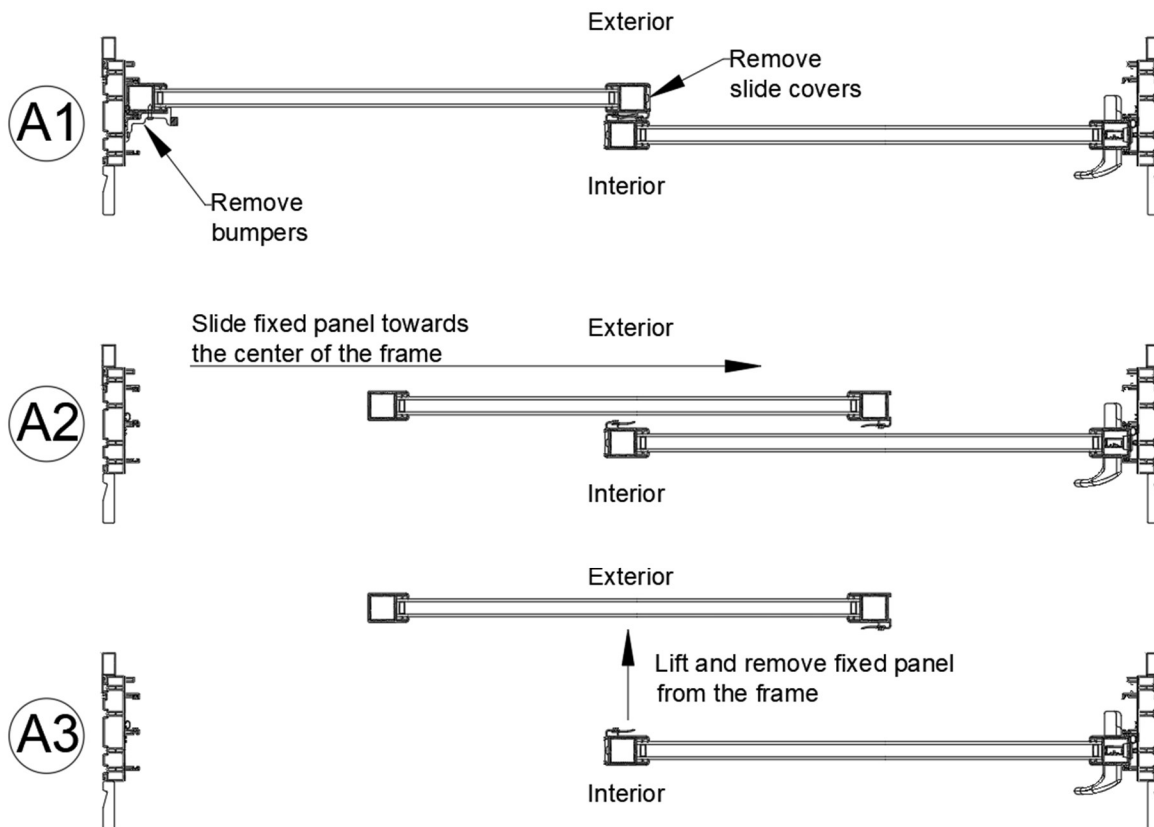

Figure 1

1.2 Rotate the panel 180°; place the panel in a safe place, before proceeding to work on the next step.

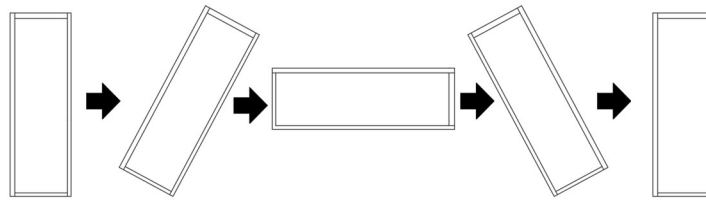

Figure 2

1.3 Unscrew and remove fixed panel support from the sill.

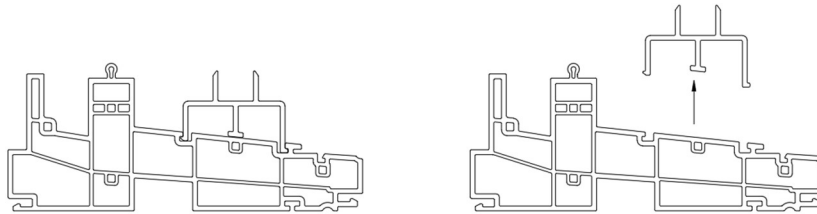

Figure 3

1.4 Reinstall panel support on the opposite side of the sill (under the fixed panel new location).

1.5 Seal with silicone and place screw caps on any screw holes left exposed on the sill.

2.0 Reverse the Operating Panel

2.1 Remove slide covers from interlock and using a screwdriver remove the lockset from the panel. Lower the panel slightly by adjusting the wheels for ease of turning (Figure 4). Slide the panel to the center of the frame; lift the panel to pull the bottom part from the sill, and then pull down to release the panel from the frame (Figure 5).

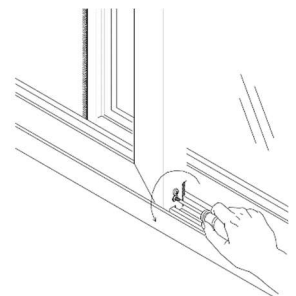

Figure 4

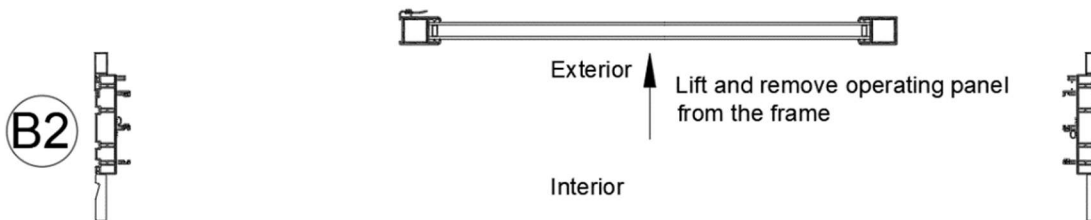
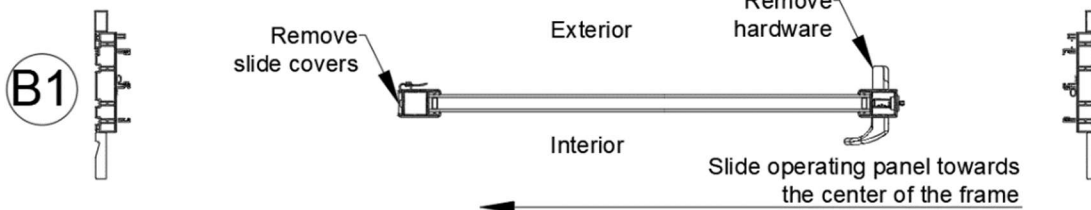

Figure 5

2.2 With the panel outside of the frame, use a handheld screwdriver to remove the rollers from the bottom of the panel.

2.3 Rotate the panel 180°; once rotated install the rollers in the bottom rail of the operating panel. Use #8x3/4" pan head tapping screw. Be sure to fasten rollers one (1") inch from ends of rails (Figure 7).

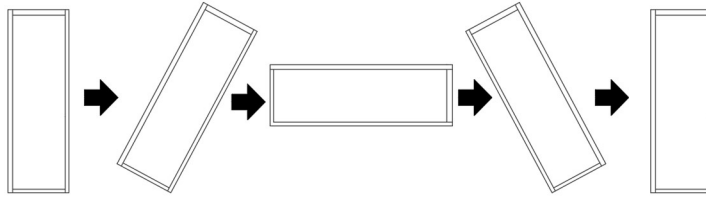

Figure 6

2.4 Place the panel in a safe place as we proceed to install the fixed panel.

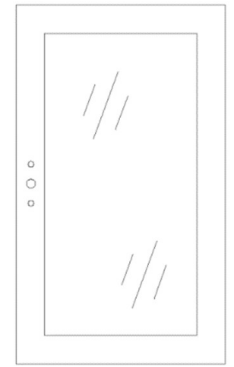

Figure 7

3.0 INSTALLING THE FIXED PANEL

3.1 From the inside of the building, lift the fixed panel into the center track of the frame header and carefully lower onto the sill as shown. The wool pile at the meeting rail should now be facing the inside of the building.



3.2 The fixed panel should be completely level with the sill, no gaps should be apparent between the sill and the bottom of the fixed panel.

3.3 Push the fixed panel securely and completely into the jamb.

3.4 You may need to use silicon spray along the sill and up the jamb to fully engage the fixed panel. If additional assistance is required use a spreader bar to push the fixed panel firmly against the jamb.

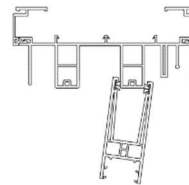

3.5 First fasten the fixed panel bumper to the top and bottom of the fixed panel with #8x3/4" (4) self-drilling screws (as shown #1).

3.6 Now fasten the fixed panel bumper to the top and bottom of the jamb with #8x1-1/4" (4) screws (as shown #2)

3.7 Now place screw caps over all the screw heads of the fixed panel bumpers.

3.4 Apply some silicone sealant and place screw caps to any holes exposed on the jamb opposite from the fixed panel.

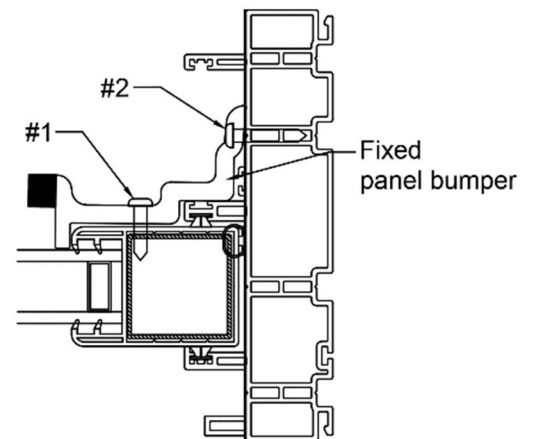

Figure 8

4.0 INSTALLING THE OPERATING PANEL

4.1 Lift the operating panel into the inside track of the frame header and carefully lower onto the roller track of sill as shown.

4.2 Using a handheld screwdriver (#2-Robertson or #2-Phillips), adjust the rollers up or down to align the top of the weather stripping on the inside of the bottom rail to be riding approximately 1/16" to 1/8" below the top edge of the sill as shown.

Turn the screw clockwise to raise the panel or counterclockwise to lower the panel as shown.

NOTE: Clearview recommends lifting the panel slightly when adjusting the wheels for ease of turning and to ensure against stripping the adjustment mechanism.

Slide the panel in the closing direction to within 1/4" of the jamb. Visually, the gap between the panel and the jamb should be uniform from top to bottom. If not, adjust the panel downward at one corner until the panel aligns to the jamb. If the jamb is bowed, remove installation screws, adjust the shims, and re-fasten.



Figure 9

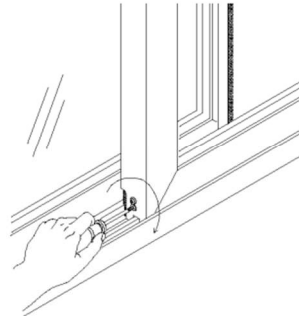

Figure 10

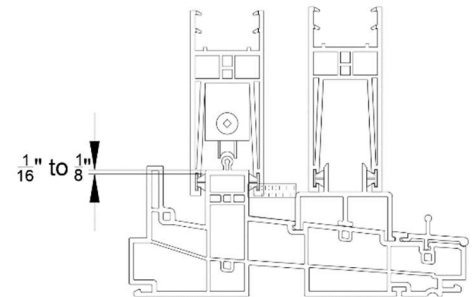

Figure 11

5.0 MORTISE LOCK HANDLE AND KEEPER INSTALLATION

5.1 Only after the panels have been adjusted as previously noted, attach the operating mechanism, handles, and lock keeper as outlined in the door hardware instruction sheet.

NOTE: Install the screws through the centre of the slots in the keeper to allow for future vertical adjustments if necessary.

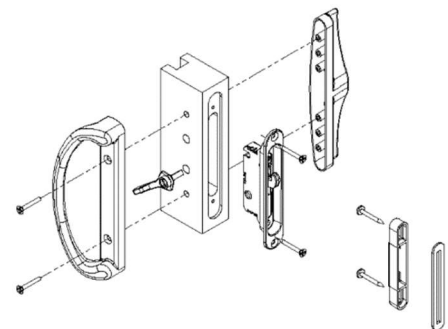

Figure 12

6.0 INSTALLING ANTI-LIFT BLOCK

6.1 The anti-lift block is installed in the header portion of the door frame above the operating panel. This is a security precaution to avoid intruders from lifting the panel while in the locked position. Slide the door to the full opened position; place the anti-lift into the centre header section where the panels interlock as shown.

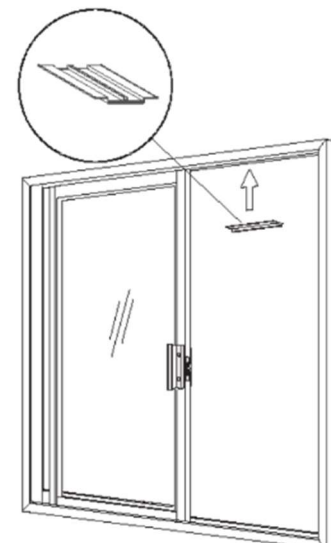

Figure 13

7.0 Reversing Screen

7.1 Before removing the screen, back-off all four wheels by turning the adjustment screws counter-clockwise.

7.2 Remove the screen from the frame.

7.3 Flip the screen around.

7.4 Insert the screen in the outside track of the frame header, swing the bottom of the screen towards the sill and snap the rollers over the sill screen track. Slide the screen in the closing direction to within 1/4" of the jamb. Visually, the gap between the screen and the jambs should be uniform from top to bottom.

7.5 Using a screwdriver (#2-Robertson or #2 Phillips) adjust the rollers on the bottom of the screen up (clockwise) or down (counter-clockwise) to align the screen. Adjust the top rollers just enough to snug the screen in the top track and allow easy rolling.

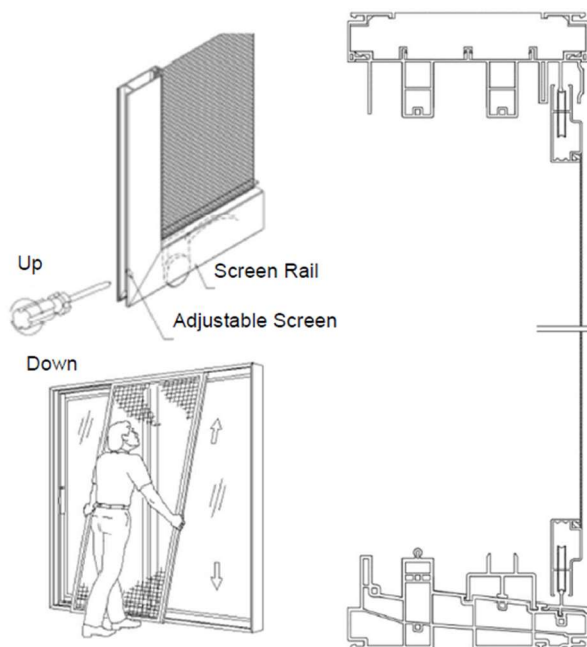

Figure 14

Visit Our Web Site @ www.clearview.on.ca

CLEARVIEW
INDUSTRIES LTD

45 Fenmar Drive
Toronto, Ontario Canada M9L1M1
Toll: 1-888-253-2739
Tel: 416-745-6666
Fax: 416-745-3711
E: sales@clearview.on.ca